

Kule Vinç yedek parçaları
Spare parts for tower cranes

2012 resimli genel Katalog

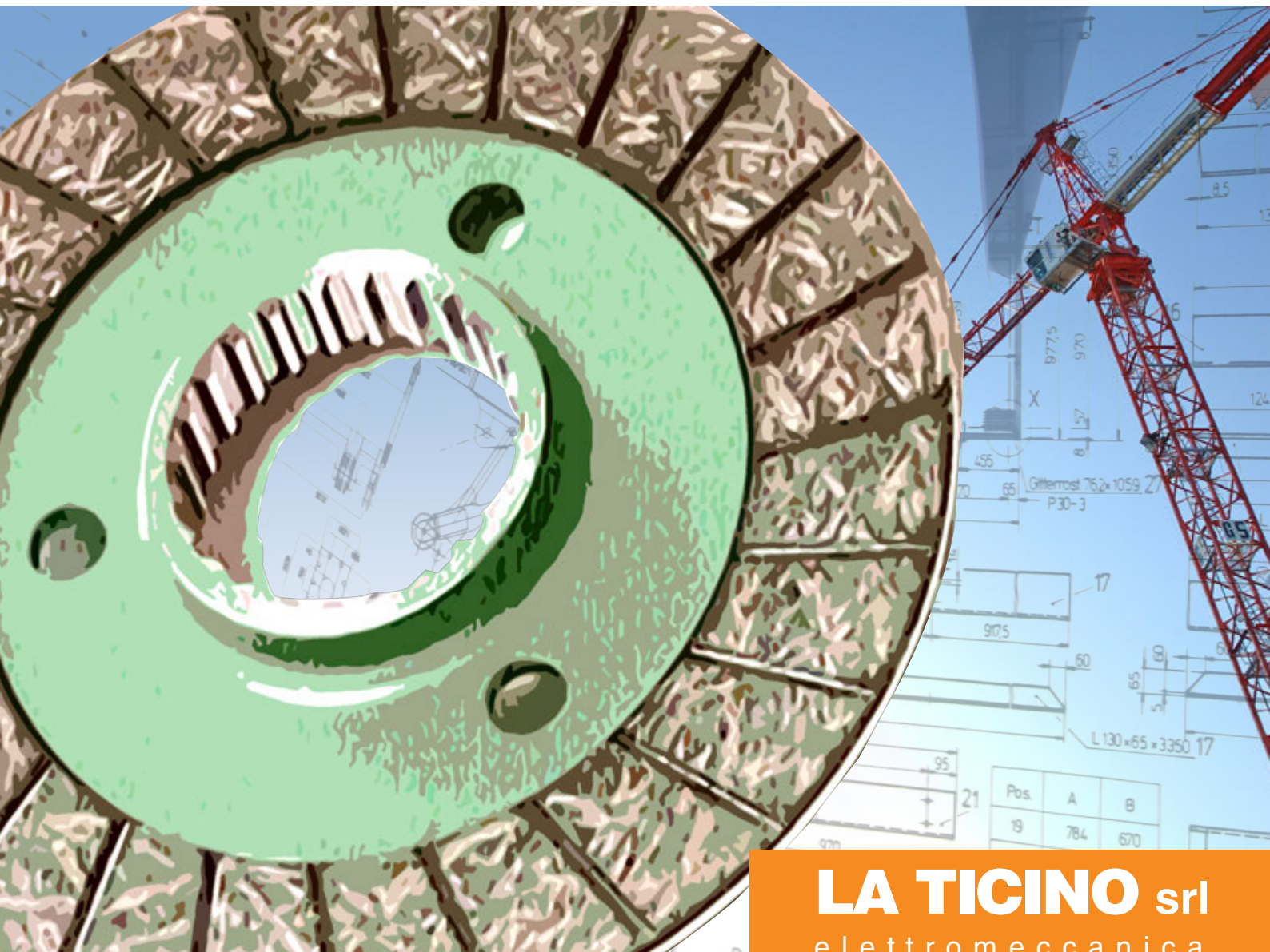

LA TICINO srl
elettromeccanica



La Ticino s.r.l.

La Ticino firması elektrikli motor için frenler geliřtirmek ve üretmek konusunda uzmanlařmış bir firma olup, kule vinçler sektöründe de çok büyük deneyimlere sahiptir.

Ayrıca, kule vinçler için fren rotasyon bolkajları, yük limitatörleri ve seller, soğutma fanları, palangalar, jantlar, yük taşıma silindirleri, ısıtıcılar, sesli alarm cihazları, joystick'ler, rektifiyeler, kumanda blokajları, düzelticiler, vidalar, kelepçeler, işareet tabelaları, hidrolik kaplinler, ridüktörler ve yavaşlatıcılar gibi aksesuarlarında ticaretini yapar. La Ticino firmasının tüm ürünleri, kalite/fiyat karşılařtırmasında ve müşteri talep ve ihtiyaçlarına göre ürünleri özelleřtirebilme konusunda da göze çarpmaktadır.



La Ticino s.r.l.

La Ticino is specialized in the development and manufacturing of brake for electric motors, with extensive experience in the field of tower cranes. It also markets a wide range of crane accessories including, among others, brake release, load cells & load panel, cooling fans, pulleys, wheels, heaters, joysticks, horn, rectifiers, screws, brackets, signs, hydraulic couplings, reducers and retarders. All the Ticino products are characterized by an excellent value for money and the possibility of personalization on request of the customer.

LA TICINO srl

elettromeccanica

Via A. Da Giussano 10/12
20029 Turbigo (MI) Italy
Tel. +39 (0)331 899083
Fax +39 (0)331 897882
info@laticino.com

Indice Index

T-FM FRENLER T-FM BRAKES	4
T-FM 68 FRENLER T-FM 68 BRAKES	5
T-FM 58 FRENLER T-FM 58 BRAKES	6
T-FM 46 FRENLER T-FM 46 BRAKES	7
T-FCPL FRENLER T-FCPL BRAKES	8
FRENI T-FCPL 158 T-FCPL 158 BRAKES	9
T-FCPL PW 60 FRENLER T-FCPL PW 60 BRAKES.....	10
T-FCPL PW 54 FRENLER T-FCPL PW 54 BRAKES	11
T-FCPL PW 50 FRENLER T-FCPL PW 50 BRAKES	12
T-FCPL H 60 FRENLER T-FCPL H 60 BRAKES	13
T-FCPL H 40 FRENLER T-FCPL H 40 BRAKES	14
KALDIRMA FRENLERİ LIFTING BRAKES	15
KALDIRMA FRENLERİ LIFTING BRAKES	16
TBK FRENLER TBK BRAKES	17
TK FRENLER TK BRAKES	18
TK GRUP FRENLERİ TK BRAKES	19
ROTASYON FRENLERİ ROTATION BRAKES	20
T-FCM / T-FCL / T-FCO ROTASYON	21
T-FCM / T-FCL / T-FCO ROTATION	
SOĞUTMA COOLING	23
ROTASYON SBLOKAJ BRAKE RELEASE	24
ELETTROMAGNETİK FRENLER	26
ELECTROMAGNETIC BRAKES	
PALANGALAR PULLEYS	29
TROLEY SİLİNDİRLERİ TROLLEYS ROLLERS	30
VİDALAR HARDWARE	31
ELEKTRİK AKSESUARLARI	32
ELECTRICAL ACCESSORIES	
CIHAZLAR INSTRUMENTATION	33
ELEKTRİK MALZEMLERİ	34
ELECTRICAL EQUIPMENT	
İŞARET PANKARTLARI PLATES	35
AKSESUARLAR ACCESSORIES	36

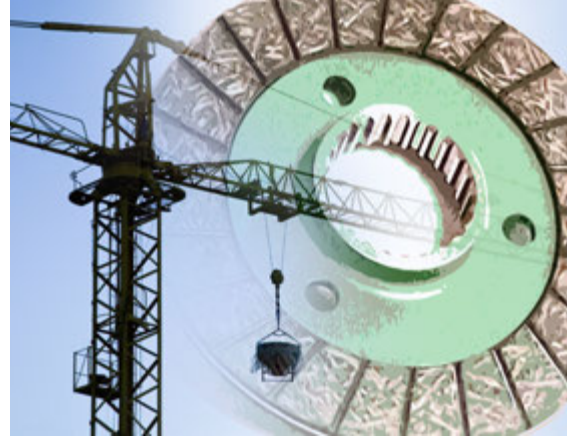

T-FM FRENLER T-FM BRAKES

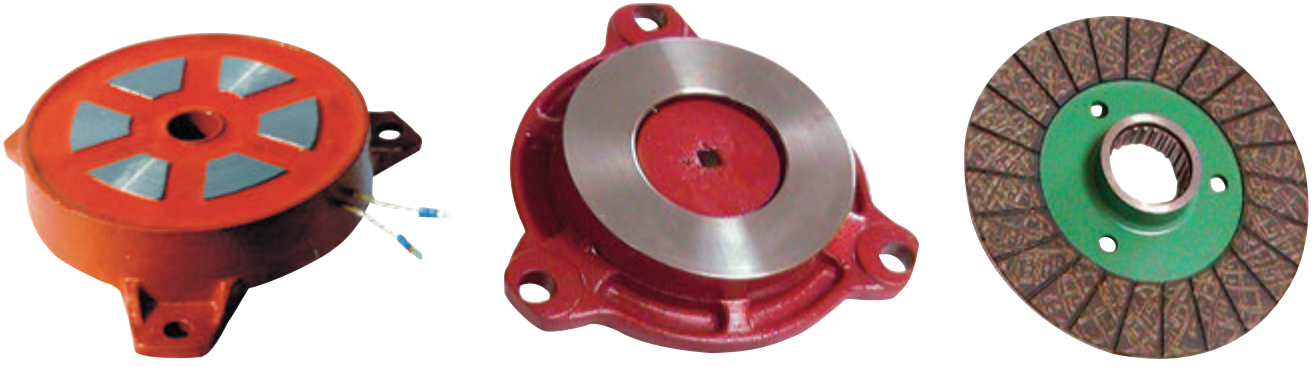

Teknik Özellikler

- 250 Nm'ye kadar frenleme torku
- Üç çap mevcut olup, geniş motor model yelpazesi ile uyumludur.
- Elektrik besleme gerilimleri için geniş yelpaze. Uzun süre bakım gerektirmeden çalışma süresi, geniş hava boşluk mesafesi.
- Hızlı ve basit bir şekilde montaj için entegre edilmiş sabitleme vidaları
- Az enerji tüketimi, normal operasyonlarda "soğuk" çalışma.
- Opsiyon üzerine manuel serbest bırakma cihazı

Specifications

- Braking torque up to 250 Nm
- Three sizes available, compatibility with a wide range motors
- Wide range of supply voltages
- Large airgap: long working time without maintenance
- Integrated fixing screws for quick and easy installation
- Low power consumption, low heat dissipated during normal operations
- Optional manual release device

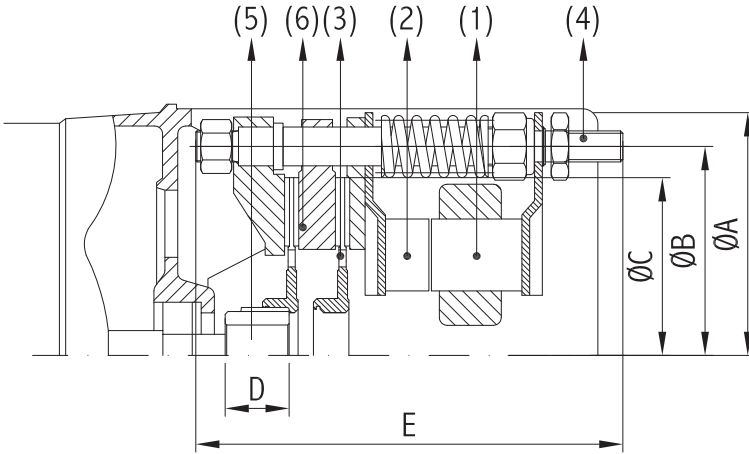

Okuma

- (1) Fren Bobini
- (2) Armatür Plakası
- (3) Fren Diski
- (4) Montaj çubukları
- (5) Frezeli göbek
- (6) Bağlantı flanşı

Legend

- (1) Brake coil
- (2) Armature plate
- (3) Brake disc
- (4) Assembly rods
- (5) Splined hub
- (6) Connection flange

Seri	Ø A [mm]	Ø B [mm]	Ø C [mm]	D [mm]	E [mm]	Not
T-FM 46	276	248	215	45	190	-
T-FM 58	308	280	250	45-73	190-220	2 disk
T-FM 68	330	308	280	73	220	2 disk

T-FM 68 FRENLER

T-FM 68 BRAKES

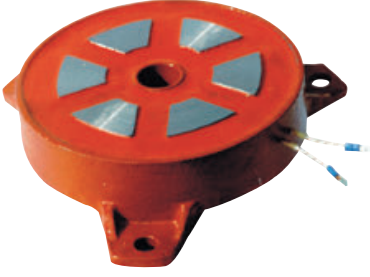

Fren bobini
brake coil

Kod.	Açıklama
00200/01	V 80/37 c.c.
00200/02	V 380 c.a.



Armatür plakası
armature plate

Kod.	Açıklama
00200/01A	Armatür plakası

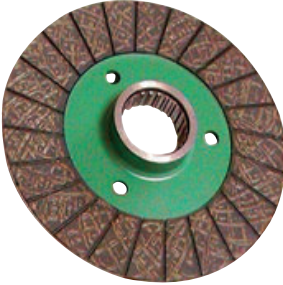

Fren diski
brake disk

Kod.	Açıklama
00200/18	168 - Ø 280mm - H 32mm Z 24



Çift fren bağlantı flanşı
connection flange for double brake

Kod.	Açıklama
00200/03	Ø est 284mm - Ø int 152mm



Frezeli göbek
splined hub

Kod.	Açıklama
00100/91-2D	frezeli fren göbeği Ø 44/50-H 73mm Z 24



Montaj saplamaları
assembly rods

Kod.	Açıklama
00190/29-1D	somunlu kolonlar ve yay U190mm
00190/30-2D	somunlu kolonlar ve yay U 220mm
00170/31	fren yayı H 55mm
00170/33	somun MB 20x1,5mm

FRENLER T-FM 58

T-FM 58 BRAKES

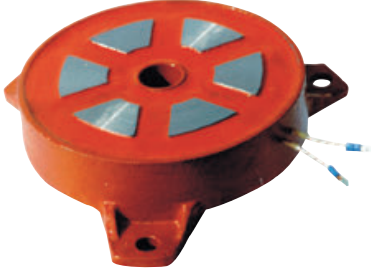

Fren bobini brake coil

Kod.	Açıklama
00180/04	V 380 c.a.
00180/05	V 20 c.c.
00180/06	V 80/37 c.c.
01180/07	V 58/37 c.c.



Armatür plakası armature plate

Kod.	Açıklama
00180/09	Armatür plakası

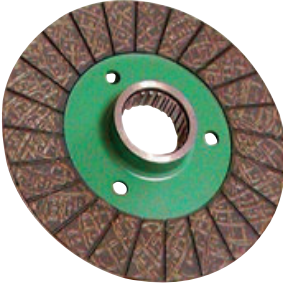

Fren diski brake disk

Kod.	Açıklama
00180/18	158 - Ø 250mm - H 21mm Z 24

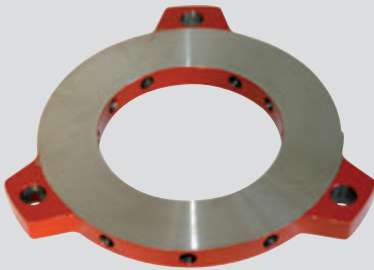

Çift fren bağlantı flanşı connection flange for double brake

Kod.	Açıklama
00180/91	Ø est 252mm - Ø int 151mm



Frezeleli göbek splined hub

Kod.	Açıklama
00100/91-2D	frezeleli fren göbeği Ø 44/50mm - H 73mm Z 24
00100/90-1D	frezeleli fren göbeği Ø 44mm - H 45mm Z 24

Montaj saplamaları assembly rods

Kod.	Açıklama
00190/29-1D	somunlu kolonlar ve yay U 190mm
00190/30-2D	somunlu kolonlar ve yay U 220mm
00170/31	fren yayı H 55mm
00170/33	somun MB 20x1,5mm

FRENLER T-FM 46
T-FM 46 BRAKES

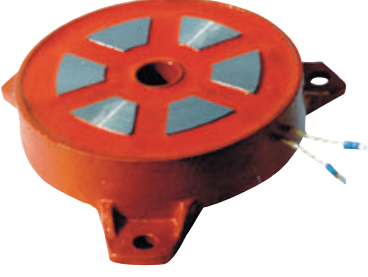

Fren bobini
brake coil

Kod.	Açıklama
00160/01	V 380 c.a.
00160/02	V 20 c.c.
00160/03	V 80/37 c.c.
00160/04	V 175 c.c.

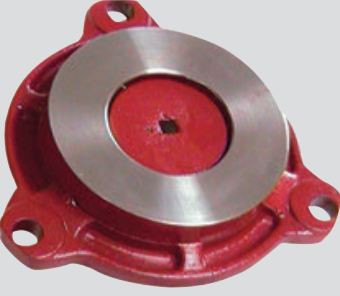

Armatür plakası
armature plate

Kod.	Açıklama
00160/08	Armatür plakası

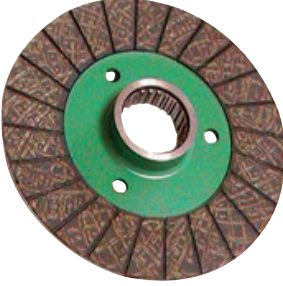

Fren diski
brake disk

Kod.	Açıklama
00160/17	146 - Ø 215mm - H 21mm Z 24



Frezeli göbek
splined hub

Kod.	Açıklama
00100/90-1D	frezeli fren göbeği Ø 44mm - H 45mm Z 24



Montaj saplamaları
assembly rods

Kod.	Açıklama
00190/29-1D	somunlu kolonlar ve yay L 190mm
00170/31	fren yayı H 55mm
00170/33	somun MB 20x1,5

T-FCPL FRENLER

T-FCPL BRAKES

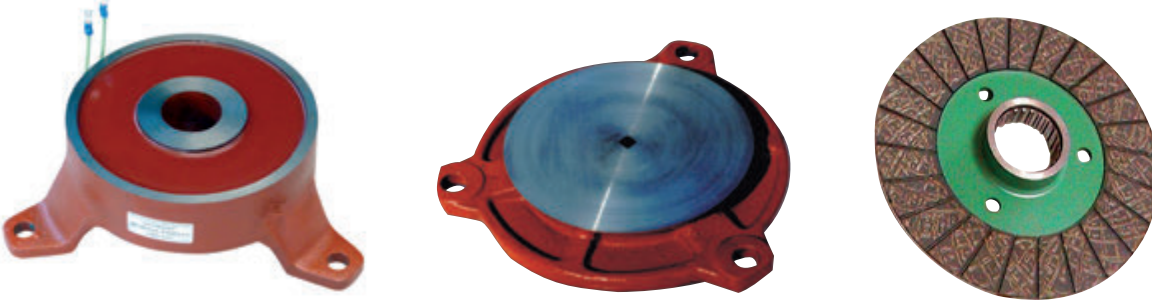

Teknik Özellikler

- 65' en 600 Nm'ye kadar frenleme torku
- Bir çok çap mevcut olup, geniş LS motor model yelpazesi ile uyumludur.
- Yüksek frenleme torkları için klipsli H (sabit) flayor
- Standart volaj: 20 ve 175 V c.c.
- Uzun süre bakım gerektirmeden çalışma süresi, geniş hava boşluk mesafesi.
- Hızlı ve basit bir şekilde montaj için entegre edilmiş sabitleme vidaları
- Az enerji tüketimi, normal operasyonlarda "soğuk" çalışma.
- Opsiyon üzerine manuel serbest bırakma cihazı

Specifications

- Braking torque from 65 to 600 Nm
- Various sizes available, compatibility with a wide range of LS Motors
- H (Hard) flavour also available, for high braking torque
- Standard voltages: 20 and 175 V d.c.
- Large airgap: long working time without maintenance
- Integrated fixing screws for quick and easy installation
- Low power consumption, low heat dissipated during normal operations
- Optional manual release device

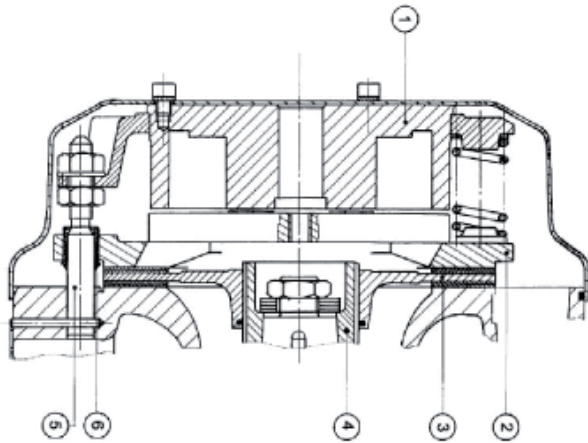

Okuma

- (1) Fren bobini
- (2) Armatür plakası
- (3) Fren disk
- (4) Jontalı göbek
- (5) Montaj çubukları
- (6) Yaylar

Legend

- (1) Brake coil
- (2) Armature plate
- (3) Brake disc
- (4) Hub
- (5) Assembly rods
- (6) Spring

Seri	Fren disk [mm]	Çift [Nm]	Bobin gerilimi [V] * c.c.
T.FCPL H 34	-	-	190
T.FCPL H 40	180	65	190
T.FCPL H 60	250	150	190
T.FCPL PW 50	250	65	20-40-175
T.FCPL PW 54	215	75	20-40-175
T.FCPL PW 60	250	150	20-175
T.FCPL 158	250	600	20-175

(*) Talep üzerine farklı c.c. besleme gücü

(*) Different d.c. voltage available on request

T-FCPL 158 FRENLER
T-FCPL 158 BRAKES



Fren bobini
brake coil

Kod.	Açıklama
00180/07	V 20 c.c.
00180/07A	V 175 c.c.

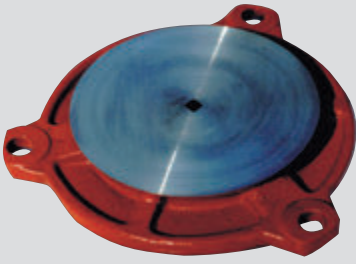

Armatür plakası
armature plate

Kod.	Açıklama
00180/10	Armatür plakası

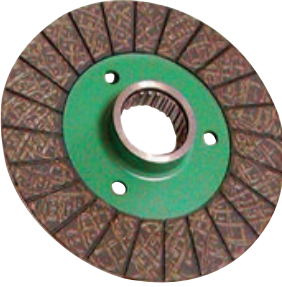

Fren diski
brake disk

Kod.	Açıklama
00180/18	158 - Ø 250mm - H 21mm Z 24



Çelik frezeli göbek
splined hub

Kod.	Açıklama
00100/90-1D	frezeli fren göbeği - Ø 44mm - H 45mm Z 24



Montaj saplamaları
assembly rods

Kod.	Açıklama
00190/28	somunlu kolonlar ve yay L 209mm
00170/31	fren yayı H 55 mm
00170/33	somun MB 20x1,5mm

T-FCPL PW 60 FRENLER

T-FCPL PW 60 BRAKES

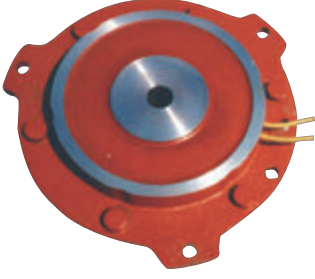

Fren bobini

brake coil

Kod.
00180/71
00180/72

Açıklama
V 20 c.c.
V 175 c.c.

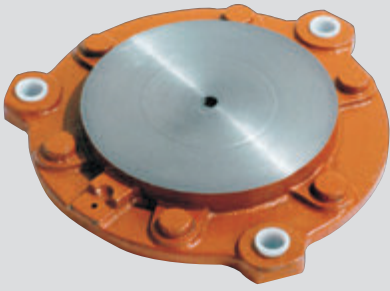

Armatür plakası

armature plate

Kod.
00180/73
00180/73B

Açıklama
Naylon burçlar ile komple montaj saplamaları
Naylon burçlar



Fren diski

brake disk

Kod.
00180/18

Açıklama
158 - Ø 250mm - H 21mm Z 24



Çelik frezeli göbek

splined hub

Kod.
00100/90-1D

Açıklama
frezeli fren göbeği Ø 40/44mm - H 45mm Z 24



Montaj saplamaları

assembly rods

Kod.
00190/34
00170/32

Açıklama
somunlu kolonlar ve yay U 148mm
DAHLANDER tipi yay H 78mm

T-FCPL PW 54 FRENLER

T-FCPL PW 54 BRAKES

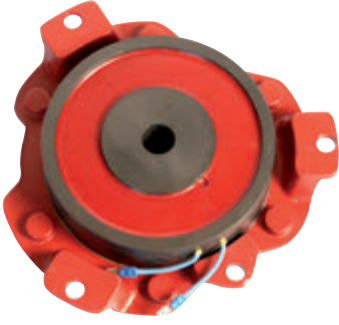

Fren bobini
brake coil

Kod.	Açıklama
00160/75	V 175 c.c.
00160/77	V 20 c.c.
00160/78	V 40 c.c.



Armatür plakası
armature plate

Kod.	Açıklama
00160/76	Naylon burçlar ile komple montaj saplamaları
00160/76B	Naylon burçlar

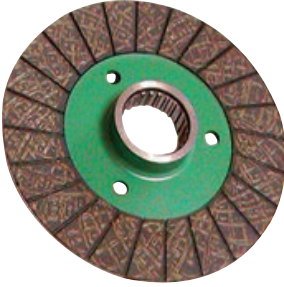

Fren diski
brake disk

Kod.	Açıklama
00160/74	Ø 215mm - H 32mm Z 24



Çelik frezeli göbek
splined hub

Kod.	Açıklama
00100/93-1D	frezeli fren göbeği H 45 Z 24



Montaj saplamaları
assembly rods

Kod.	Açıklama
00190/35	somunlu kolonlar ve yay U 110mm
00170/32	DAHLANDER tipi yay H 78mm

T-FCPL PW 50 FRENLER

T-FCPL PW 50 BRAKES

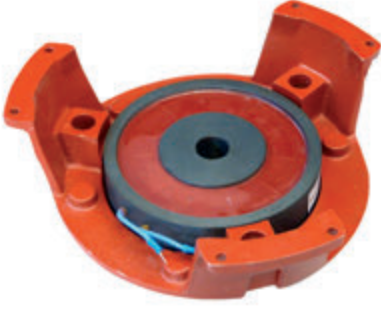

Fren bobini brake coil

Kod.	Açıklama
00150/79	V 175 c.c.
00150/78	V 20 c.c.
00150/77	V 40 c.c.

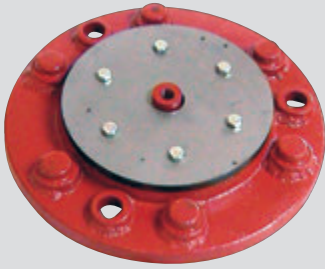

Armatür plakası armature plate

Kod.	Açıklama
00150/80	Armatür plakası

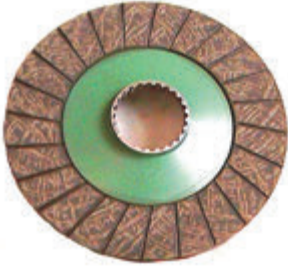

Fren diski brake disk

Kod.	Açıklama
00150/81	Ø 250mm Z 24



Çelik frezeli göbek splined hub

Kod.	Açıklama
00100/90-1D	Frezeli fren göbeği H 45 Z 24



Ankoraj plakası kiti kit armature plate

Kod.	Açıklama
00105/A	Komple KIT içindekiler: 4 büyük yay, 3 küçük yay, 3 pin, 1 vida
00170/40	Büyük yay KIT H 60mm
00170/41	Küçük yay KIT H 20mm

T-FCPL H 60 FRENLER

T-FCPL H 60 BRAKES



Fren bobini
brake coil

Kod.
00210/60

Açıklama
V 190 c.c. (2 mikro şalter)



Armatür plakası
armature plate

Kod.
00210/61

Açıklama
Armatür plakası

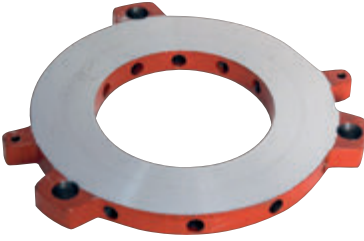

Çift fren bağlantı flanşı
connection flange for double brake

Kod.
00210/62

Açıklama
çıkartılabilir disk

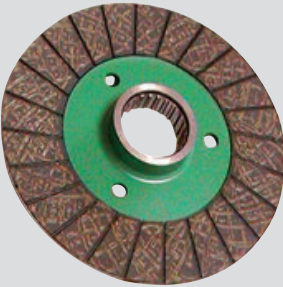

Fren diski
brake disk

Kod.
00180/18

Açıklama
158 - Ø 250mm - H 21mm Z 24



Çelik frezeli göbek
splined hub

Kod.
00100/92-1D

Açıklama
frezeli fren göbeği Ø 40mm H 30mm Z 24

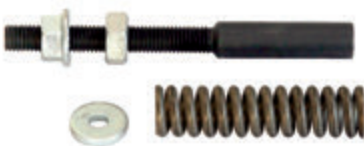

Ankoraj plakası kiti
assembly rods

Kod.
00190/62
00170/63

Açıklama
Komple KIT içindekiler: somun ve yay
yay KIT H 60mm

T-FCPL H 40 FRENLER

T-FCPL H 40 BRAKES



Fren bobini
brake coil

Kod.
00210/40

Açıklama
V 190 c.c.



Armatür plakası
armature plate

Kod.
00210/41

Açıklama
Armatür plakası



Fren diski
brake disk

Kod.
00210/42

Açıklama
Ø 180mm - Z 24



Çelik frezeli göbek
splined hub

Kod.
00100/92-1D

Açıklama
frezeli fren göbeği Ø 40mm H 30mm Z 24

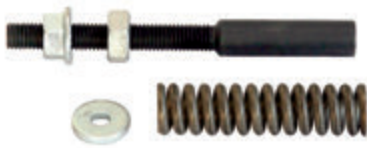

Ankoraj plakası kiti
assembly rods

Kod.
00190/43
00170/50

Açıklama
Komple KIT içindekiler: somun ve yay
yay KIT H 69 mm

KALDIRMA FRENLER LIFTING BRAKES

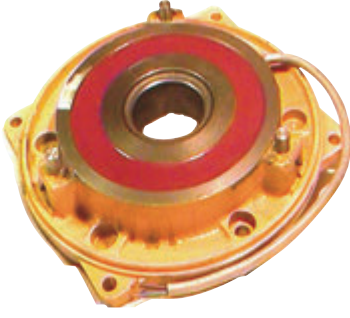

Flanşlı fren bobini
brake coil with flange

Kod.	Açıklama
00180/88	V 180/20 c.c.
00170/88	yay



Havalandırılmalı fren diski
brake disc

Kod.	Açıklama
00180/87	Fren diski



Fren bobini
brake coil

Kod.	Açıklama
00160/56	V 24 c.c.
00160/57	V 380 c.a.



Fren bobini T-FCPL H34
brake coil

Kod.	Açıklama
00210/34	V 190 c.c.

KALDIRAÇ FRENLERİ

LIFTING BRAKES



Fren diski
brake disk

Kod.
00180/81
00180/83
00180/84

Açıklama
ciem tipi Ø 270 x 185mm Z 40
edilmac tipi göbekli çıkarılabilir Ø 235 x 155mm Z 23
edilmac tipi göbekli çıkarılabilir Ø 225 x 155mm Z 29

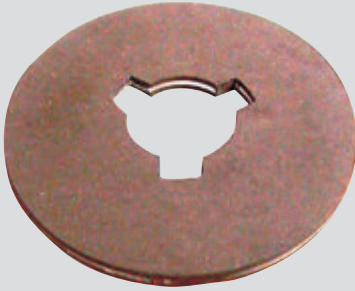

Fren diski
brake disk

Kod.
00180/82

Açıklama
edilmac tipi Ø 200mm Z 3



Piastre intermedie
connection flange for double brake

Kod.
00180/85
00180/85B

Açıklama
edilmac tipi flanş Ø 220 x 135mm
edilmac tipi flanş Ø 260 x 165mm

TBK FRENLER

TBK BRAKES



TBK 07/01



TBK 07/03

Teknik Özellikler

- 100'den 300 Nm'ye kadar frenleme torku
- Bir çok çap mevcut olup, geniş LS Motor yelpazesi ile uyumludur.
- Standart voltaj: 20, 190 V c.c.
- Uzun süre bakım gerektirmeden çalışma süresi, geniş hava boşluk mesafesi
- Hızlı ve basit bir şekilde montaj için entegre edilmiş sabitleme vidaları
- Az enerji tüketimi, normal operasyonlarda "soğuk" çalışma

Specifications

- Maximum braking torque from 100 to 300 Nm
- Various sizes available, compatibility with a wide range of LS Motors
- Standard voltages: 20 and 190 V d.c.
- Large airgap: long working time without maintenance
- Integrated fixing screws for quick and easy installation
- Low power consumption, low heat dissipated during normal operations

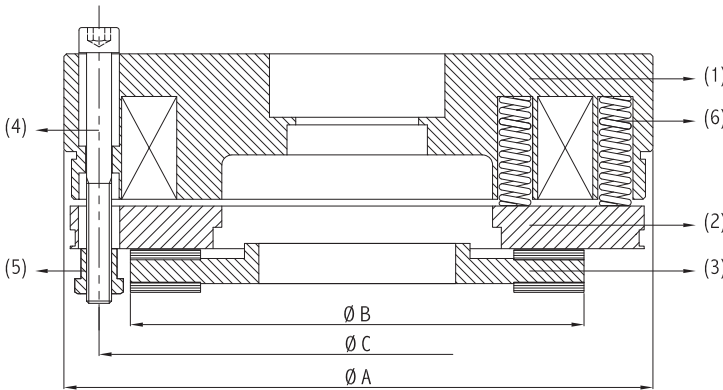

Okuma

- (1) Fren bobini
- (2) Ancoraj plakası
- (3) Fren diski
- (4) Sabitleme vidası
- (5) Ayar somunu
- (6) Yaylar

Legend

- (1) Brake coil
- (2) Armature plate
- (3) Brake disc
- (4) Fixing screw
- (5) Adjustment nut
- (6) Spring

Seri	Ø A [mm]	Ø B [mm]	Ø C [mm]	Çift [Nm]	Vc.c. [V]
TBK 07	192,5	153	172	100/150	20/190
TBK 08	235	181	206	150/300	20/190

TK FRENLER

TK BRAKES



Teknik Özellikler

- 15'den 750 Nm'e kadar frenleme torku
- Fren torku sabit veya ayarlanabilir
- Standart voltaj: 24, 190 V c.c
(talep üzerine diğer voltajlar)
- Az enerji tüketimi, normal operasyonlarda "soğuk" çalışma
- Kolay montaj: fren torku ve ara mesafe önceden ayarlıdır.
- Düşük hava sıcaklığında çalışma imkanı
- Yüksek fren torku (H) ve çift fren diskli (D) versiyonu mevcuttur.

Specifications

- Maximum braking torque from 15 to 750 Nm
- Fixed or adjustable brake torque
- Standard voltages: 24, 180 V d.c.
(other voltages available on request)
- Low power consumption, low heat dissipated during normal operations
- Easy installation: torque and airgap thickness pre-set
- Suitable for use at low temperatures
- Available H (high torque) and D (double brake disc) version

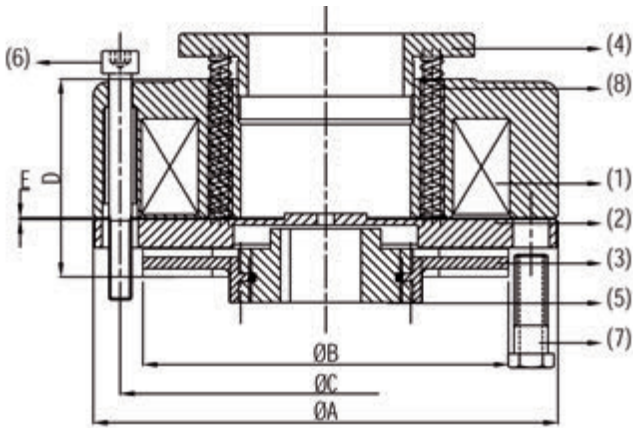

Okuma

- (1) Fren bobini
- (2) Acoraj plakası
- (3) Fren diskli
- (4) Tork ayar halkası
- (5) Frezeli göbek
- (6) Sabitleme vidaları
- (7) Ayar somunu
- (8) Yay

Legend

- (1) Brake coil
- (2) Armature plate
- (3) Brake disc
- (4) Torque adjustment ring
- (5) Splined hub
- (6) Fixing screw
- (7) Adjustment nut
- (8) Spring

Seri	Ø A [mm]	Ø B [mm]	Ø C [mm]	D [mm]	E [mm]	Tork [Nm]	V.c.c. [V]
TK 04	129	94	112	48,5	0,5 - 0,6	15	24/190
TK 05	150	119	132	60,5	0,5 - 0,6	30	24/190
TK 06	163	127	145	70,5	0,5 - 0,6	60	24/190
TK 07	190	152	170	76,5	0,5 - 0,6	75	24/190
TK 08/08D	217	174	196	82,5/105,5	0,5 - 0,6	150/300	24/190
TK 09/09D	255	202	230	94,5/124,5	0,5 - 0,6	250/500	24/190
TK 10/10H	305	250	278	98	0,5 - 0,7	500/750	24/190

TK FRENLER GRUBU

TK BRAKES



Fren bobini

brake coil

Kod.

TK 04 / 01
TK 05 / 01
TK 06 / 01
TK 07 / 01
TK 08 / 01
TK 09 / 01
TK 10 / 01

Ankoraj plakası dahil torku ayarlanabilir fren bobini. Tork ayarlı yapılamayan da mevcuttur. Opsiyonel olarak TK 05 ve TK 06 için manuel sblokaj kollu versiyon mevcuttur.

Brake coil for torque-adjustable brake with armature plate. Optionally available coil for fixed-torque brake. Optionally available manual brake release for TK 05 and TK 06



Fren diski

brake disk

Kod.

TK 04 / 03
TK 05 / 03
TK 06 / 03
TK 07 / 03
TK 08 / 03
TK 09 / 03
TK 10 / 03

Açıklama

Ø 94mm Z 26
Ø 119mm Z 20 - Z30
Ø 127mm Z 20 - Z34
Ø 152mm Z 20
Ø 174mm Z 20 - Z23 - Z31
Ø 202mm Z 28 - Z37
Ø 250mm Z 24



Göbek

UNI 6604 standardına göre anahtar oyuğu UNI 6604
splined hub

Kod.

TK 04 / 05
TK 05 / 05
TK 06 / 05
TK 07 / 05
TK 08 / 05

TK 09 / 05
TK 10 / 05

Açıklama

Z 26 H 20mm Ø 10mm
Z 20 H 25mm Ø 20mm - H 25mm Ø 20mm - Z 30
Z 20 H 25 Ø 20 - H 30mm Ø 25 - Z 34
Z 20 H 35mm Ø 34mm
Z 20 H 19/35/40mm Ø 24/28/32/34mm - Z 23 H 40mm Ø 32mm
Z 31 H 35mm Ø 35mm
Z 28 H 52mm Ø 48mm - Z 37 H 60mm Ø 38mm
Z 24 H 45mm Ø 43mm



Rotasyon sblokajı

brake release

Kod.

00105/25
TK kapak

Açıklama

Rotasyon sblokajı 24 V c.c. / 48 V c.a.
Koruyucu kapak Ø 205mm - 100mm



Çift diskli versiyon
Double disk version



Ayarlanamayan fern torku
Non-adjustable braking torque



Manuel sblokaj
Manual release

ROTASYON FRENLER ROTATION BRAKES



Teknik Özellikler

- 6'dan 32 Nm'a kadar frenleme torku
- Beş ölçü mevcut (71, 80, 90, 112, 132), Bir çok çap mevcut olup, geniş LS Motor yelpazesi ile uyumludur.
- Standart voltaj: 20 V c.c.
- Geniş hava mesafesi: Uzun süre bakım gerektirmeden çalışma süresi,
- Kendinden soğutmalı (fanlı)
- Az enerji tüketimi, normal operasyonlarda "soğuk" çalışma
- Manuel sblokaj cihazı opsiyonel.

Specifications

- Braking torque from 6 to 32 Nm
- Five sizes available (71,80,90,112,132) compatibility assured with a wide range of LS motors
- Standard voltage: 20 V d.c.
- Large airgap: long working time without maintenance
- Self-ventilating
- Low power consumption
- Optional manual release devices

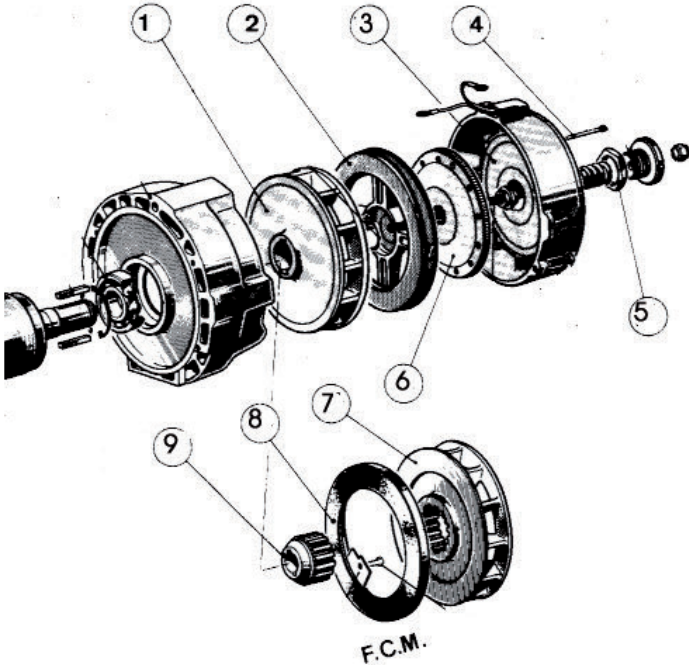

Okuma

T-FCO T-FCL

- (1) Sökülebilir fan disk (anahtar kaması)
- (2) Contalı koron
- (3) Fren bobini
- (4) Vida yeri
- (5) Yay kutusu
- (6) Ayar disk

T-FCM

- (7) Çıkarılabilir fan disk (frezeli göbek)
- (8) Conta
- (9) Frezeli göbek

Legend

T-FCO T-FCL

- (1) Removable fan disk (key hub)
- (2) Armature plate
- (3) Brake coil
- (4) Locating screw
- (5) Locknut / compression spring
- (6) Adjustment disk

T-FCM

- (7) Removable Fan disk (splined hub)
- (8) Linings
- (9) Splined hub

Seri	Tork [Nm]	Bobin Voltajı [V] * c.c.
90	6	20
112	19	20
132	32	20

(*) Talep üzerine farklı d.c. besleme gücü
(*) Different d.c. voltage available on request

T-FCM / T-FCL / T-FCO ROTASYONLAR

T-FCM / T-FCL / T-FCO ROTATION

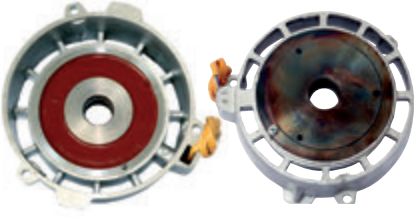
**Fren bobini**
brake coil

Kod.	Açıklama
00080/10	Fren bobini V 20 c.c.
00090/11	Fren bobini V 20 c.c.
00090/11 B	özel voltaj
00112/12	Fren bobini V 20 c.c.
00112/12 B	özel voltaj
00132/01	Fren bobini V 20 c.c.
00132/01 B	özel voltaj

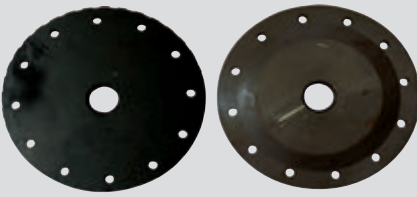
**Armatür plakası**
armature plate

Kod.	Açıklama
00080/18	V 80 - Ø est 106mm
00090/19	V 90 - Ø est 125mm
00112/20	V 112 - Ø est 150mm
00132/21	V 132 - Ø est 170mm

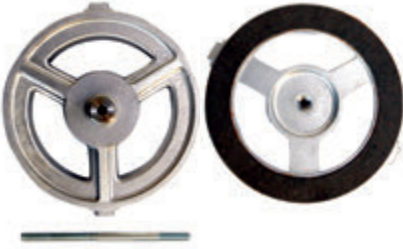
**Çelik göbek**
lined wheel

Kod.	Açıklama
00080/12	V 80 - Ø est 137mm
00090/13	V 90 - Ø est 155mm
00112/14	V 112 - Ø est 175mm
00132/15	V 132 - Ø est 215mm

**Çelik frezeli göbek**
splined hub

Kod.	Açıklama
MZ V 90	Göbek V 90 Z 16
MZ V 112	Göbek V 112 Z 20
MZ V 132	Göbek V 132 Z 22

T-FCM / T-FCL / T-FCO ROTASYONLAR

T-FCM / T-FCL / T-FCO ROTATION



Çıkarılabilir contalar linings

Kod.	Açıklama
00090/50	V 90 - Ø est 153mm
00112/51	V 112 - Ø est 170mm
00132/52	V 132 - Ø est 215mm



Fan diski (anahtar kaması) fan disk (key hub)

Kod.	Açıklama
00080/79 A	V 80 anahtar - Ø 139mm
00090/80 A	V 90 anahtar - Ø 155mm
00112/81 A	V 112 anahtar - Ø 175mm
00132/82 A	V 132 anahtar - Ø 225mm



Fan diski (göbekli) fan disk (splined hub)

Kod.	Açıklama
00090/80	V 90 - göbekli Ø 155mm
00112/81	V 112 - göbekli Ø 175mm
00132/82	V 132 - göbekli Ø 225mm

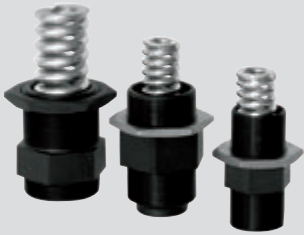

Yay kutusu spring box

Kod.	Açıklama
00090/27	V90 ayar manivelası, yay, somun tutucu
00112/28	V112 ayar manivelası, yay, somun tutucu
00132/28	V132 ayar manivelası, yay, somun tutucu



Komple elektrik fanı electric fan

Kod.	Açıklama
00112/40	V 380 c.a. - 250 W - IP55
00112/40 A	V 220 c.a. - 250 W - IP55
00112/42	sudan koruma kapağı



Komple elektrik fanı complete electric fan

Kod.	Açıklama
00180/40	V 380/400 c.a. - 550 W - IP55
00180/41	çelik pervane
00180/42	sudan koruma kapağı
00180/43	bant dahil fan desteği

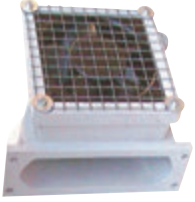

Komple elektrik fanı electric fan

Kod.	Açıklama
00112/39	V 220/230 c.a. - 27,5 W

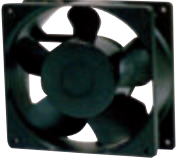

Komple elektrik fanı electric fan

Kod.	Açıklama
00701/40	V 220/230 c.a. - 27,5 W

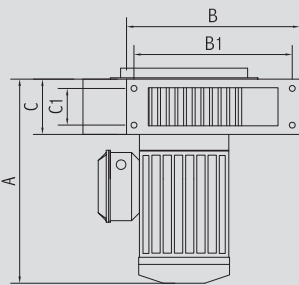

YANDAN GÖRÜNÜM

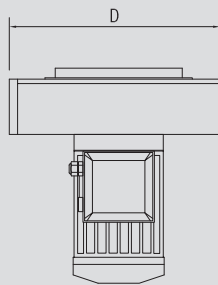

ÖNDEN GÖRÜNÜM

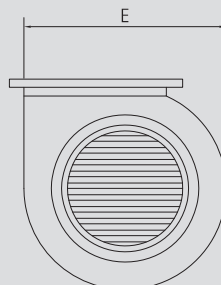

ÇİZİM

Seri	A	B (B1)	C (C1)	D	E
00112/39	-	- (174,5)	- (40,5)	-	-
00112/40	225	191 (174,5)	61 (40,5)	223	230
00112/40A	225	191 (174,5)	61 (40,5)	223	230
00180/40	275	142 (115)	137 (115)	263	228

ROTASYON SBLOKAJI

BRAKE RELEASE



Açıklama

Sabit elektromekanik fren sblokaj cihazı, elektrik kensitesi olduğu durumlarda dahi motorun serbest rotasyonunu sağlar. Kule vinç üzerinde, vinç dönme motorları için özellikle geliştirilmiş olan bu elektromekanik fren aksesuarları, emniyet frenini boşa alarak, alakalı olduğu motorun serbest rotasyonunu sağlar.

Ürünün en önemli özelliği yapısallığının basitliği olup, buda düşük maliyet, kolay montaj ve tavsiye edilen kullanım alanı dahilinde son derece güvenilirlik anlamını taşır.

Fren rotasyon sblokajı, fren kolu kullanılarak manuel olarak yapılır veya uzaktan basit bir presedür takip edilerek yapılır.

NOT

Fren rotasyon sblokajı, sürekli olmadan ve en fazla 10 işlem/gün olarak projelendirilmiştir. Sürekli müdehalenin gerekli olduğu durumlarda, tavsiye edilen ürünleri için La Ticino kullanım kılavuzunu inceleyiniz. Manuel fren kolu opsiyoneldir

DESCRIPTION

Brake release device for electromechanical brake, allows the free rotation of the engine in case of power failure.

Developed specifically for tower crane rotation engines, this accessory allows to disengage the brakes ensuring the free rotation of the cranes, as required by law.

The strength of the product is its simple construction, which translates into low cost, ease of installation and high reliability when used in according to recommended workload.

Installation simply requires the setting of a special spacer screw to be made after the installation of the brake release, and requires little to no maintenance during product lifetime.

The brake can be released manually using the lever and release button, or can be remotely controlled by following few, simple steps.

NOTE

Brake release are not designed for continuous service (not more than 10 operations/day). For heavier duty, please contact LaTicino for specific products. Manual brake release lever optionally available.

Voltaj	Dış Çap [mm]	Max Yükseklik [mm]	Uyumlu frenleri
20V c.c. / 48V c.a.	216	108	Seri TK 05 ve TK 06

ROTASYON SBLOKAJI BRAKE RELEASE



Rotasyon sblokajı
brake release

Kod.
00105/25

Açıklama
V 20 c.c. / 48 c.a.

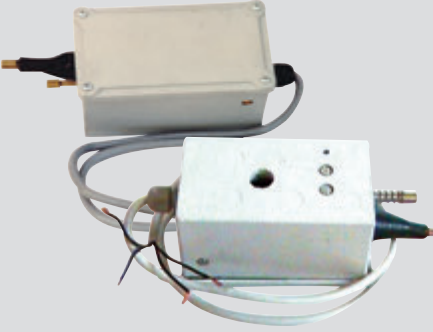

Rotasyon sblokajı
brake release

Kod.
00105/26

Açıklama
V 20 c.c. / 48 c.a.

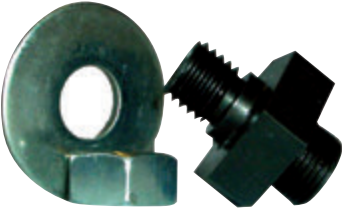

Destek vidası
support screw

Kod.
VPS 105/26

Açıklama
destek sadece 00105/26 için gerekli



Destek vidası
relay

Kod.
00105/24

Açıklama
V 20 c.c. / 48 c.a.

ELEKTROMAGNETİK FRENLER ELECTROMAGNETIC BRAKES



Teknik Özellikler

- 9 dan 250 Nm'e kadare frenleme torqu
- Bir çok çapp mevcutü
- Standart voltaj: 380 V c.a., 24 ve 175 V d.c.
- Uzun süre bakım gerektirmeden çalışma süresi
- Hızlı ve basit bir şekilde montaj için entegre edilmiş sabitleme vidaları
- Az enerji tüketimi, normal operasyonlarda "soğuk" çalışma

Specifications

- Braking torque from 9 to 250 Nm
- Various sizes available
- Standard voltage: 380 V a.c., 24 and 175 V d.c.
- Long working time maintenance free
- Integrated fixing screws for quick and easy installation
- Low power consumption, low heat dissipated during normal operations

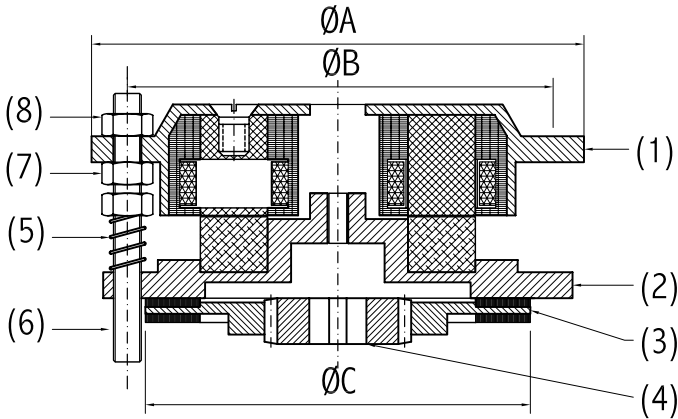

Okuma

- (1) Fren bobini
- (2) Ancoraj plakası
- (3) Fren diski
- (4) Frezeli sürücü
- (5) İtme yayı
- (6) Sürücü kolon
- (7) Ayar somunu
- (8) Kilitleme somunu

Legend

- (1) Brake coil
- (2) Armature plate
- (3) Brake disc
- (4) Splined hub
- (5) Spring
- (6) Assembly rods
- (7) Nut
- (8) Locknut

Özellikler ve özelçüler Features and Dimensions

Seri	Ø A [mm]	Ø B [mm]	Ø C [mm]	Fren Torqu [mm]	Vcc-Vca [V]
70	129,5	114,5	101	9	380 c.a., 175, 24 c.c.
80	144,5	124,5	113,5	17	380 c.a., 175, 24 c.c.
90	169,5	145	122,5	35	380 c.a., 175, 24 c.c.
100	179	159,5	143	48	380 c.a., 175, 24 c.c.
110	199	169,5	155	70	380 c.a., 175, 24 c.c.
120	229	200,5	183	90	380 c.a., 175, 24 c.c.
140	239,5	210	193	130	380 c.a., 175, 24 c.c.
160	250	225	204	150	380 c.a., 175, 24 c.c.
180	325	290	249	250	380 c.a., 175, 24 c.c.
200	325	290	249	250	380 c.a., 175, 24 c.c.

ELEKTROMAGNETİK FRENLER

ELECTROMAGNETIC BRAKES

Fren bobini

brake coil



Kod.	Açıklama	Kod.	Açıklama
TM 70	V 380 c.a.	TM 70 A	V 175 V 24 c.c.
TM 80	V 380 c.a.	TM 80 A	V 175 V 24 c.c.
TM 90	V 380 c.a.	TM 90 A	V 175 V 24 c.c.
TM 100	V 380 c.a.	TM 100 A	V 175 V 24 c.c.
TM 110	V 380 c.a.	TM 110 A	V 175 V 24 c.c.
TM 120	V 380 c.a.	TM 120 A	V 175 V 24 c.c.
TM 140	V 380 c.a.	TM 140 A	V 175 V 24 c.c.
TM 160	V 380 c.a.	TM 160 A	V 175 V 24 c.c.
TM 180	V 380 c.a.	TM 180 A	V 175 V 24 c.c.
TM 200	V 380 c.a.	TM 200 A	V 175 V 24 c.c.

Mıknatıs karşıtı ancoraj plakası

armature plate



Kod.	Açıklama
TC 70	Ankoraj plakası
TC 80	Ankoraj plakası
TC 90	Ankoraj plakası
TC 100	Ankoraj plakası
TC 110	Ankoraj plakası
TC 120	Ankoraj plakası
TC 140	Ankoraj plakası
TC 160	Ankoraj plakası
TC 180	Ankoraj plakası
TC 200	Ankoraj plakası

Montaj saptırmaları

assembly rods



Kod.	Açıklama
TT 70	8 x 73 M6 M8
TT 80	8 x 80 M6 M8
TT 90	10 x 95 M8 M10
TT 100	10 x 98 M8 M10
TT 110	10 x 103 M10
TT 120	12 x 120 M12
TT 140	12 x 145 M12
TT 160	12 x 145 M12
TT 180	14 x 195 M14
TT 200	

Çift fren için bağlantı flanşı

connection flange for double brake



Kod.	Açıklama
TP 70	Döküm flanş
TP 80	Döküm flanş
TP 90	Döküm flanş
TP 100	Döküm flanş
TP 110	Döküm flanş
TP 120	Döküm flanş
TP 140	Döküm flanş
TP 160	Döküm flanş
TP 180	Döküm flanş
TP 200	Döküm flanş

ELEKTROMAGNETİK FRENLER

ELECTROMAGNETIC BRAKES



Fren diski mozzo

brake disk (hub)

Kod.	Açıklama
TDM 70	Z 15
TDM 80	Z 15
TDM 90	Z 15
TDM 100	Z 20
TDM 110	Z 20
TDM 120	Z 20
TDM 140	Z 20
TDM 160	Z 23
TDM 180	Z 28
TDM 200	Z 28



Fren diski (kovanlı)

brake disk (sleeve)

Kod.	Açıklama
TDS 70	Z 6
TDS 80	Z 6
TDS 90	Z 6
TDS 100	Z 6
TDS 110	Z 6
TDS 120	Z 6 - 8
TDS 140	Z 8
TDS 160	
TDS 180	
TDS 200	



Çelik frezeli göbek

splined hub

Kod.	Açıklama
TMZ 70	Z 15 H 16-32mm Ø 14mm
TMZ 80	Z 15 H 16-30mm Ø 18mm
TMZ 90	Z 15 H 16-32mm Ø 24mm
TMZ 100	Z 20 H 19-35mm Ø 24-28mm
TMZ 110	Z 20 H 19-35mm Ø 28mm
TMZ 120	Z 20 H 35mm Ø 32mm
TMZ 140	Z 20 H 19-35-40mm Ø 34mm
TMZ 160	Z 23 H 40mm Ø 42mm
TMZ 180	Z 28 H 52mm Ø 48mm
TMZ 200	Z 28 H 52mm Ø 48mm

PALANGALAR

PULLEYS



Palanga (teneke)

pulleys (sheet)

Kod.	Açıklama
010	Ø 278 - 230mm - delik Ø 35mm
015	Ø 313 - 265mm - delik Ø 35mm
020	Ø 300 - 250mm - delik Ø 35mm
030	Ø 348 - 295mm - delik Ø 40mm
035	Ø 348 - 295mm - delik Ø 40mm sürgülü
040	Ø 205 - 170mm - rulman Ø 35mm
050	Ø 175 - 145mm - çıplak delik Ø 47mm
060	Ø 480 - 420mm - delik Ø 60mm
070	Ø 205 - 170mm - delik Ø 30mm



Palanga (Poliamid)

pulleys (nylon)

Kod.	Açıklama
510	Ø 165 - 138mm - delik Ø 25mm
520	Ø 130 - 110mm - delik Ø 20mm
530	Ø 185 - 160mm - delik Ø 30mm
540	Ø 235 - 205mm - delik Ø 40 - con boccola Ø 30mm
550	Ø 235 - 205mm - delik Ø 35mm
560	Sürgülü Ø 235 - 205mm - delik Ø 40mm
570	Ø 340 - 280mm - delik Ø 50mm



Palanga (Döküm)

pulleys (cast iron)

Kod.	Açıklama
080	Ø 190 - 165mm - delik Ø 25mm
090	Ø 350 - 287mm - delik Ø 40mm
09B	Ø 350 - 287mm - delik Ø 50mm
09C	Ø 350 - 287mm - delik Ø 45mm
100	sürgülü Ø 350 - 287mm - delik Ø 50mm
10B	sürgülü Ø 350 - 287mm - delik Ø 60mm
110	Ø 400 - 333mm - delik Ø 40mm
120	sürgülü Ø 400 - 333mm - delik Ø 80mm
130	Ø 290 - 238mm - delik Ø 30mm
140	sürgülü Ø 290- 238 - delik Ø 50mm

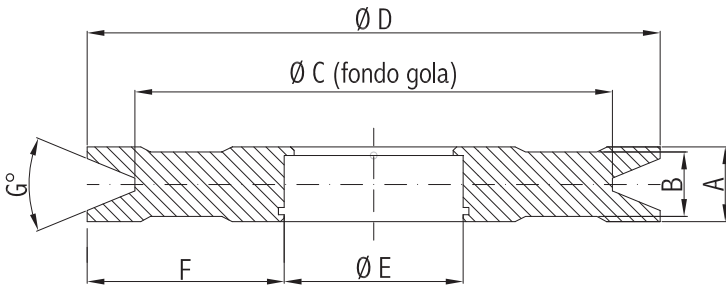

TALEP ÜZERİNE ÖZEL ÖLÇÜLERDE PALANGA İMAL EDİLİR
CUSTOM PULLEYS AVAILABLE ON REQUEST

	A	B	Ø C	Ø D	Ø E	F	G°
TALEP ÜZERİNE PALANGALAR							

TROLEY TEKERLEKLERİ TROLLEY ROLLERS



Trolley telkerlekleri (çelik) trolley rollers (steel)

Kod. 80 A **Açıklama** Ø 80/100 - H 35mm - delik Ø 30mm - Rulman n. 1 - 6206 RS

Kod. 100 E **Açıklama** Ø 100 - H 30mm - delik Ø 35mm - Rulman n. 1 - 6208 2RS



Kod. 105 B
100 G
110 N **Açıklama**
Ø 105/125 - H 50mm - delik Ø 35mm - Rulman n. 1 - 6207 2RS
Ø 78/100 - H 35mm - delik Ø 25mm - Rulman n. 1 - 6205 2RS
Ø 110/140 - H 43mm - delik d Ø 35mm - Rulman n. 1 - 6207 2RS



Kod. 105 C **Açıklama** Ø 105/125 - H 43mm - delik Ø 30mm - Rulman n. 1 - 6307 2 RS



Kod. 110 D
145 F **Açıklama**
Ø 110 - H 46mm - delik Ø 35mm - Cuscinetti n. 2 - 6207 RS
Ø 145 - H 48mm - delik Ø 40mm - Cuscinetti n. 2 - 6208 RS



Kod. 110 L
100 O **Açıklama**
Ø 110 - H 40mm - delik Ø 35mm - Rulman n. 1 - 6307 2RS
Ø 100 - H 40mm - delik Ø 30mm - Rulman n. 1 - 6206 RS



Trolley telkerlekleri (poliamide) trolley rollers (nylon)

Kod. 77 I **Açıklama** Ø 77/108 - H 40mm - delik Ø 25mm - Rulman n. 1 - 6005 2RS

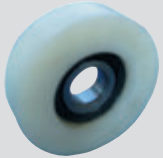

Kod. 120 M **Açıklama** Ø 120 - H 35mm - delik Ø 30mm - Rulman n. 1 - 6306 RS

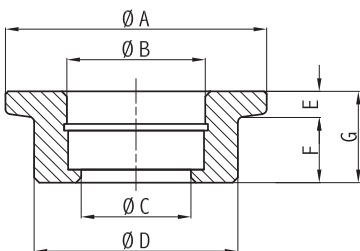

TALEP ÜZERİNE ÖZEL ÖLÇÜLERDE MAKARA İMAL EDİLİR ROLLERS AVAILABLE ON REQUEST

	Ø A	Ø B	Ø C	Ø D	E	F	G
TALEP ÜZERİNE ÖZEL MAKARALAR							

VİDA VE SOMUNLAR

BOLTS AND NUTS



Vidalar

screws

Kod.

00200/55
00200/51
00200/10
00200/16
00200/09
00200/53
00200/46
00200/47
00200/71
00200/73

Açıklama

pin vida: M 20 24x25x60mm - 8.8
pin vida: M 20 24x33x67mm - 8.8
pin vida: M 20 24x40x76mm - 8.8
pin vida: M 24 28x36x78mm - 8.8
pin vida: M 24 28x49x95mm - 8.8
pin vida: M 20 24x120x155mm - 8.8
elastik pul : M 20 137B ondüle
elastik pul : M 24 137B ondüle
somunlar: M 20 UNI 5588
somunlar: M 24 UNI 5588



Sertifikalı kelepçeler

clamps

Kod.

00200/59
00200/60
00200/69
00200/68
00200/70 A
00200/60 B

Açıklama

kelepçe Ø 30mm
kelepçe Ø 36mm
kelepçe Ø 36mm
kelepçe Ø 40mm
kelepçe Ø 42mm
kelepçe Ø 45mm

A

750
1100
1400
1050
1300
1300

B

M30x120
M36x200
M36x200
M39x200
M42x180
M45x170

C

160
192
192
240
240
240

D

150
200
210
260
230
210

00200/58
00200/70
00200/68 A
00200/60 A
00200/70 B

somun M30 UNI 5587
somun M36 UNI 5587
somun M39 UNI 5587
somun M42 UNI 5587
somun M45 UNI 5587

TALEP ÜZERİNE ÖZEL ÖLÇÜLERDE KELEPÇELER İMAL EDİLİR

CUSTOM SCREWS & CLAMPS AVAILABLE ON REQUEST

	Ø	A	B	C	D
TALEP ÜZERİNE KELEPÇELER					

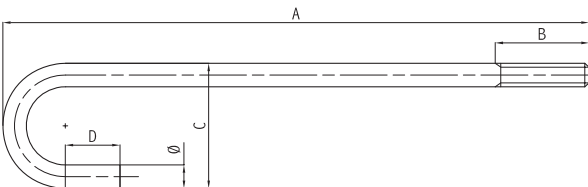

ELEKTRİKLI AKSESUARLAR ELECTRICAL ACCESSORIES



Stufetta elettrica cab heater

Kod.
00380/23

Açıklama
kabin için 380 V
Talep üzerine daha düşük ısılar mevcuttur



Ventilatör small fan for crane cabin

Kod.
00701/40B

Açıklama
kabin için yönlendirilebilir ventilatör



Korna horn

Kod.
00105/22
00105/22 A
00105/22 B

Açıklama
V 48 c.a. - Ø 130/100mm (korna grubu sabitleme deliği)
V 48 c.a. - Ø 91/80mm (korna grubu sabitleme deliği)
V 48 c.a. - Ø 74/56mm (korna grubu sabitleme deliği)



Fren balata ve tamponları brake pads

Kod.
00500/02
00500/37
00500/01
00500/01 A

Açıklama
tampon - M6 Ø 50x80mm
kaucuk koniler
fren balataları
naylon kelepçe



Yük limitleme pimi load pin

Kod.

1/300
1/300 A

Açıklama

yeni yük limitleme pimi
revizyondan geçmiş yük limitleme pimi



Yük limitleme kartı card

Kod.

1/400
1/400 A

Açıklama

yeni yük limitleme kartı
revizyondan geçmiş yük limitleme kartı



İlerleme limit şalteri limitswitch

Kod.

BFC/01
LC/01

Açıklama

İlerleme limit şalteri kol sonu XC1 AC 126
Yük sınırlayıcı ilerleme sonu XC1 AC 121



İlerleme limitleyicileri switch

Kod.

1/100
1/100 4c
1/250
1/300 B 4c
1/250 C 4c
1/50 4c
DİŞLİ KAM YEDEK PARÇALARI M5 - M20 E Z 8 - Z 12

Açıklama

kaldırma ilerleme sonu 2C
rotasyon ilerleme sonu 4C
otasyon ilerleme sonu 2C
fine corsa sollevamento 4C
kaldırma ilerleme sonu 4C
troley ilerleme sonu 4C



Manipolatör driver control

Kod.

MP/01

Açıklama

manipolatör kombinatör XKBA 1233

ELEKTRİK MALZEMELERİ ELECTRICAL EQUIPMENT

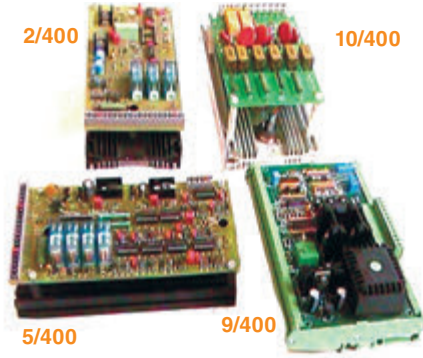

Kumanda blokajları block

Kod.	Açıklama
2/400	RCV GMR 3 kafalı
5/400	RCV GAT
9/400	kumanda blokajı DVV
10/400	statör blokaj

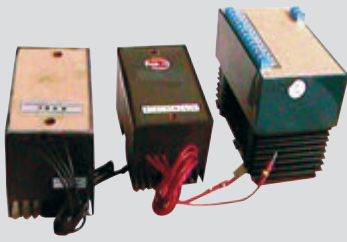

Kumanda blokajları block

Kod.	Açıklama
3/400	RCE/N - 13 kabloi
4/400	kumanda blokajı 3A - 4 kabloi
6/400	kumanda blokajı 6 kabloi
7/400	RCO + OMD - 5A - 7 kabloi
8/400	OMD - 5A - 8 kabloi



Doğrultucular bridge rectifier

Kod.	Açıklama
00050/21	dahlander tipi pw 54 220 V
00040/21	doğrultucu Semikron SKB 30
00030/21	doğrultucu yarı dalgalı 440 V a.c. 1A d.c.



Mikro Şalterler microswitches

Kod.	Açıklama
00060/21	emniyet mikro şalteri T-FCPL
00060/21B	emniyet mikro şalteri T-FCPL



Limitatore di carico load limiter - limiteurs de chargement - ladung-begrenzer

Kod.	Açıklama
T4 AD	4 mikro şalter – yük min/max: 300/2000 Kg hassassiyet: 40 Kg Fe 510 D

PLAKALAR PLATES



Kol karşıt plakaları type plates

Açıklama

Yapışkan telalı – talep üzerine sizin ölçüleriniz için teklif hazılanır



YAPIŞTIRMA yaptırılır adhesive numbers

Kod.

00500/38

Açıklama

Yapışkan numaralar H 130mm – num. 0'dan num. 9'a

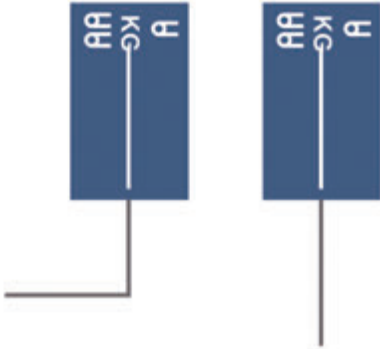

Kollu tabelalar type plates

Kod.

15431
16140
16140B
16140C
750301

Açıklama

Uzun kollu tabela
Kısa kollu tabela
Düz kollu tabela
Küçük kollu tabela
Kule yük kapasite tabela

AKSESUARLAR ACCESSORIES



Hidrolik kaplinler hydraulic coupling

Kod.

00101/01
00102/01
00103/01
00105/01

Açıklama

Kaplin Ø 255mm
Makara Ø131 E (ilkel Ø125) 2 yollu SPA/A
Makara Ø106 E (ilkel Ø100) 3 yollu SPA/A
Torkun mil Ø 24 - Ø 28mm



Rotor 33 kanatlı rotor

Kod.

33/33
33/33A

Açıklama

yeni
tamir edilmiş



Ridüktör slew reducer

Açıklama

R 141,5 M10 - Z 12 - Ø 160mm - Ø 145mm



Elektrodinamik fren electrodyn brake

Açıklama

V220 - 380 50 Hz
Kgm 5.5 - 1450 rpm - B5
flanş Ø 250mm - krank 28 x 60
frenleyici 24 V cc
elektrik sblokajı ile birlikte



Elektrodinamik fren electrodyn brake

Açıklama

V220 - 380 50 Hz
Kgm 5.5 - 1450 rpm - B5
flanş Ø 200mm
frenleyici 24 V cc
elektrik sblokajı ile birlikte



Kule vinçler için yedek parçalar

İtalyan ve Uluslararası müşterilerimize haftalık teslimatlar yapmaktayız.

Spare parts for tower cranes

We supply customers all over the world with weekly delivery.



LA TICINO srl

elettromeccanica

Via A. Da Giussano 10/12
20029 Turbigo (MI) Italy
Tel. +39 (0)331 899083
Fax +39 (0)331 897882
info@laticino.com



www.laticino.com